

SMART CITY

Smart Lighting System & Beyond

iNET™

IoT INTELLIGENT
LIGHTING CONTROL
SYSTEM

E-LITE semicon

Website: <http://www.elitesemicon.com>



iNET™ IoT Intelligent Lighting Control System

INTRODUCTION



Background

Lighting is an essential element of modern society. From outdoor street lights to household lights, lighting affects people's mood and sense of security. Unfortunately, lighting is also a major energy user. To reduce electricity demand and thereof the carbon footprint, LED lighting technology has been widely accepted and implemented to upgrade the legacy lighting. This global transition provides not merely an opportunity for energy-saving initiative but a feasible gateway to adopt an intelligent IoT platform, which is critical for smart-city solutions.

The existing LED lighting infrastructure could be used to create a powerful light sensory network. With embedded sensor+control nodes, the LED lights work to collect and transmit a wide variety of data from environment humidity and PM2.5 to traffic monitoring and seismic activity, from sound to video, so as to support many city services and initiatives across a single common platform without adding significantly more physical infrastructure.

Value Proposition

- Drastically reduce energy consumption, costs, and maintenance by using LED technology combined with dynamic, per-light controls.
- Improve city safety and security, increase violation capture.
- Enhance situational awareness, real-time collaboration, and decision making across city agencies, help optimize urban planning, increase city revenues.

iNET™ IoT Intelligent Lighting Control System

SOLUTION OVERVIEW

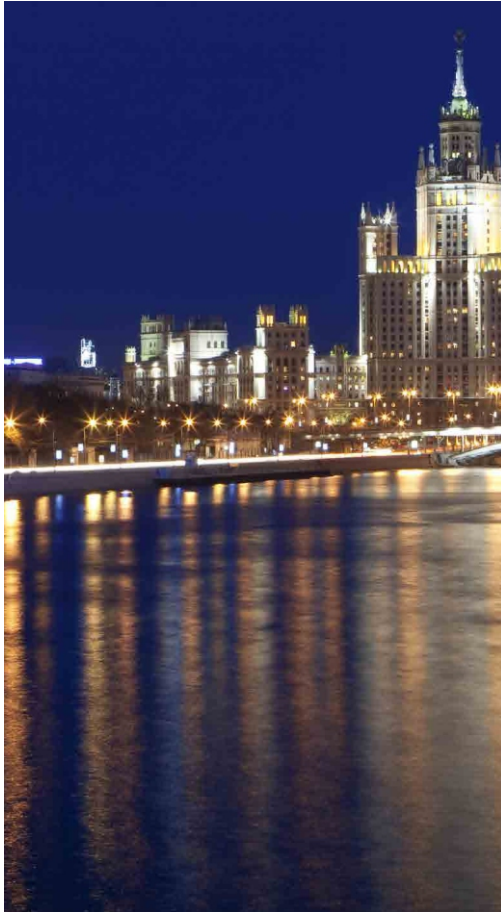

Solution Overview

E-LITE iNET IoT solution is a wireless based public communication and intelligent control system featured with mesh networking technology.

• Central Control & Management

iNET Cloud provides a cloud-based central management system(CMS) for provisioning, monitoring, controlling and analyzing lighting systems. This secure platform helps cities, utilities and operators reduce energy usage and maintenance costs, while also increasing safety. iNET Cloud integrates automated asset monitoring of controlled lighting with real-time data capture, providing access to critical system data such as power consumption and fixture failure. The result is improved maintenance and operational savings. iNET also facilitates development of other IoT applications.

• Gateway & Controller Node

The gateway communicates with server via cellular or ethernet wiring if available, and communicates with controller nodes using SUB-1GHz radio frequency (ISM 433MHz). The controller node features mesh networking, which ensures each and every instruction from server could be received and performed via the gateway. All terminal performance could be monitored from mobile devices. Proven stable communication distance from the gateway to the node is 1000m, each gateway may cover up to 1000 nodes.

Applications

- Street light control system
- Sports complex lighting control system
- Industrial facility lighting control system
- Agricultural facility light control system

INET™ IoT Intelligent Lighting Control System

SYSTEM FEATURES & SYSTEM TOPOLOGY



System Features



Automatic Light On/Off & Dimming Control

- By time setting
- On/off or dimming with motion sensor detection
- On/off or dimming with photocell detection

Accurate Operation & Fault Monitor

- Real-time monitor on each light working status
- Accurate report on fault detected
- Provide location of fault, no patrol required
- Collect each light operation data, such as voltage, current, power consumption



Extra I/O Ports for Sensor Expandability

- Environment Monitor
- Traffic Monitor
- Security Surveillance
- Seismic Activities Monitor



Reliable Mesh Network

- Self proprietary wireless control node
- Reliable node to node, gateway to node communication
- Up to 1000 nodes per network
- Max. network diameter 2000m



Easy-to-use Platform

- Easy monitor on each and all lights status
- Support lighting policy remote set-up
- Cloud server accessible from computer or hand held device



System Topology

Fig1. Wired connection mode

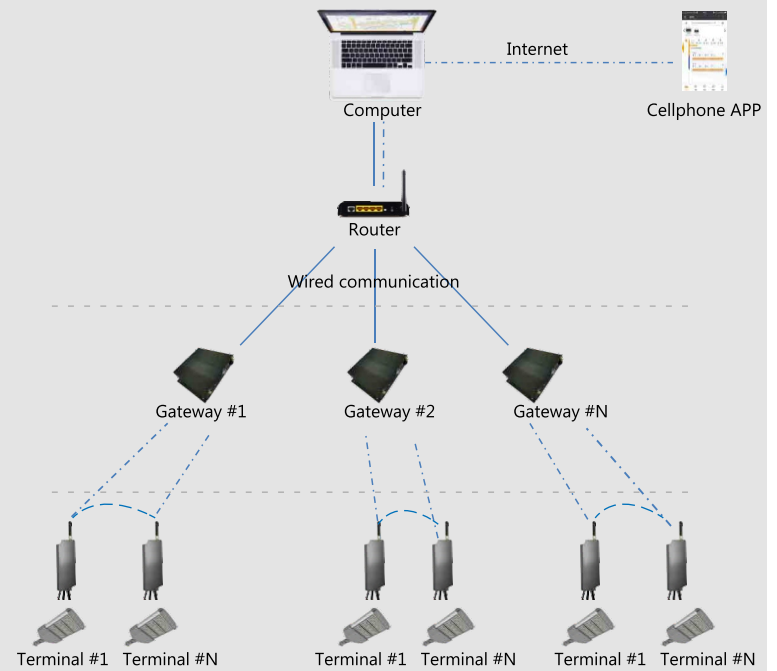
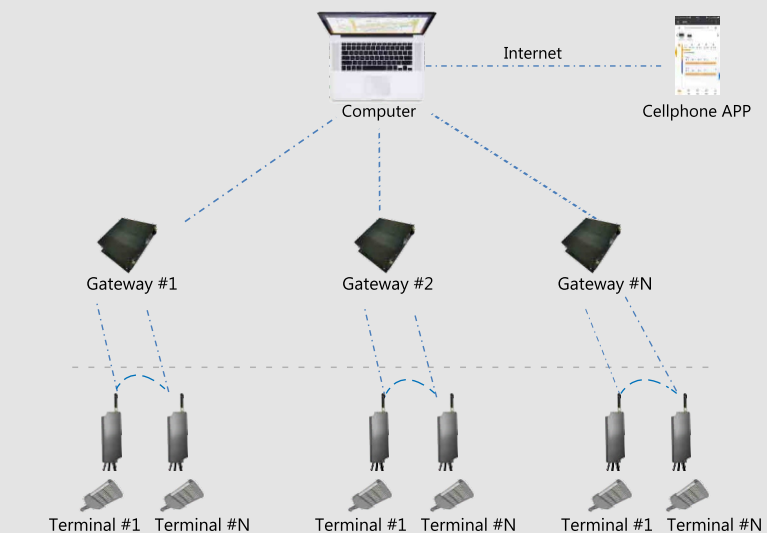

Fig2. Wireless connection mode



iNET™ IoT Intelligent Lighting Control System

iNET CLOUD



Software for Server

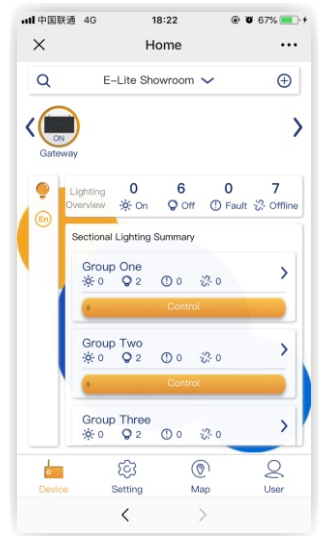

Cellphone APP

Product Description

iNET Cloud provides a cloud-based central management system(CMS) for provisioning, monitoring, controlling and analyzing lighting systems. This secure platform helps cities, utilities and operators reduce energy usage and maintenance costs, while also increasing safety. iNET Cloud integrates automated asset monitoring of controlled lighting with real-time data capture, providing access to critical system data such as power consumption and fixture failure. The result is improved maintenance and operational savings. iNET also facilitates development of other IoT applications.

Operation

Users access iNET Cloud securely over the Internet via a web browser on a computer or mobile device to manage, monitor, and control lighting networks. iNET Cloud includes a modern and intuitive graphical map with representative illustrations of individual control devices. For indoor applications, a floor plan is integrated with the map application for seamless control. Managers can set up notifications for critical alerts to update maintenance staff about faults in real time.

Features and Benefits

- Scales to thousands of locations with a unified single user interface for all.
- Accessible via browser on laptop, tablet or smartphone using highly secure encrypted communication.
- Enables monitoring assets in real time, validating and auditing energy code compliance, and identifying performance changes over time.
- E-mails and SMS notifications for fixture failures and other critical faults to improve lighting system up-time.
- Simplifies real-time schedule overrides using graphical map and floor plan views.
- Works with motion and photocell sensors to reduce energy use and extend lamp life.

iNET™ IoT Intelligent Lighting Control System

iNET CLOUD

Platform

- iNET Cloud is a multi-tenant solution, developed using upto-date web technologies, which is portable across various platforms and web interfaces. The user interface is supported on modern browsers including Chrome, Firefox and Edge.

Security

- iNET Cloud is built on a highly secured platform. The security measures are applied at various levels through the system. All the communication interfaces with iNET use SSL encryption with AES security. It also provides rolebased user access which can be restricted at different levels of a geozone hierarchy. The iNET Cloud password policy requires users to create strong passwords based on industrial standards. The timeout mechanism after multiple failed login attempts also prevents attacks.

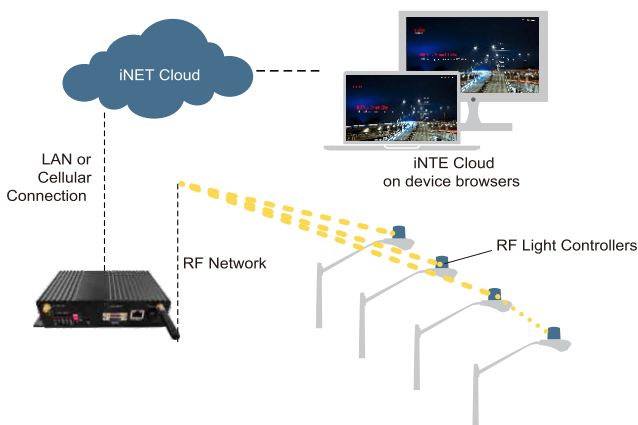

Typical smart city or campus RF communication network.

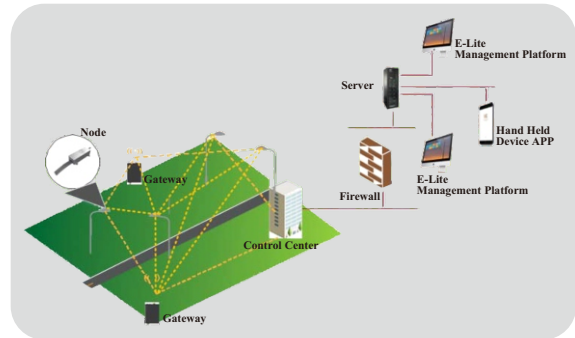

E-Lite Street Lighting & Control Network

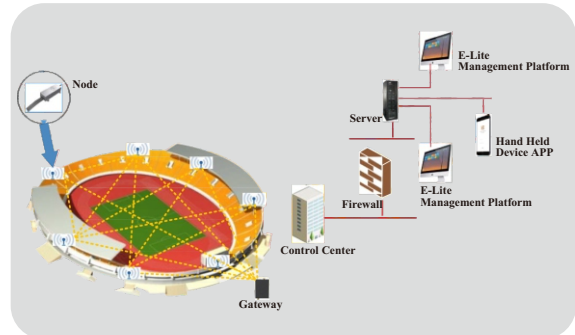

Sports Complex Lighting & Control Network

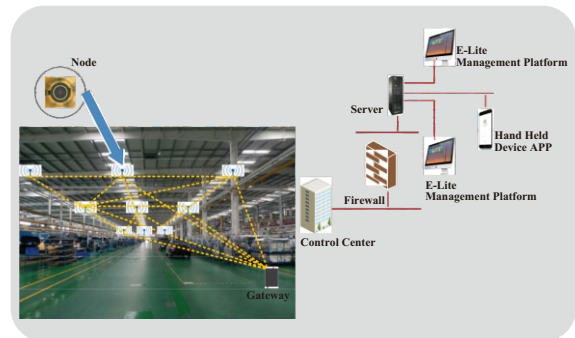

Industrial Complex Lighting & Control Network

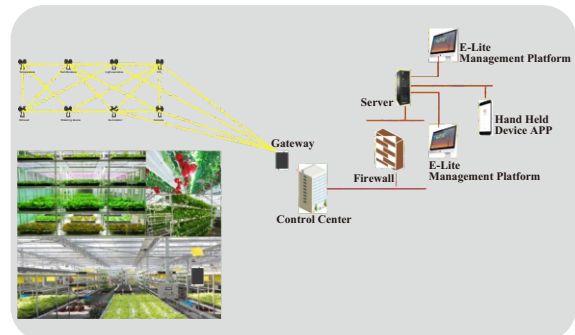

Agricultural Lighting & Control Network

iNET™ IoT Intelligent Lighting Control System

iNET CLOUD

System Description

- **Asset Management:** Users can create, import, export and modify any device attribute, such as pole information (coordinates, pole type, etc.) and fixture information (pre/post installation wattage, lamp type, etc.). Users can search assets by name, unique ID numbers, model numbers, etc., to locate the correct asset for updating or editing. iNET also performs GIS to GPS matching on devices to correlate the pole IDs with according devices, eliminating the need to record the individual device IDs during installation.
- **Monitoring and Control:** iNET Cloud provides a map-based interface to monitor and control all the lighting assets. The mapping function is also extended to floor plans for internal structures such as parking garages. Users can view the fixture status (on, off, dim), device health, etc., and perform overrides from the map/floor plans. When viewing alarms on the map, users can easily locate and troubleshoot faulty devices and configure replacement devices. User can also request collected data including wattage, current, etc. for specific assets or all data point.
- **Grouping and Scheduling:** iNET Cloud allows logical grouping of assets for event scheduling. The scheduling engine provides the flexibility to assign multiple schedules to a group, thereby keeping the regular and special events on separate schedules and avoiding user setup errors. The scheduling engine determines the daily schedule based on the event priority and sends appropriate information to various groups.
- **Data Collection:** iNET Cloud automatically collects granular data several times a day on various data points including light level, energy use, faults, etc. It enables users to establish different monitoring levels for selected data points such as voltage, current, power factor, etc. for analysis and trouble shooting.
- **Alarming and Logging:** iNET Cloud provides built-in alarms for different asset classes including lights, gateways, etc., which can be configured to send email notifications. The system constantly monitors lighting controllers for failure conditions such as lamp failure, night outages, day burners, etc., and report status several times each day to expedite failure notifications. The map/floor plan view highlights assets with alarms enabling users to quickly and easily locate and troubleshoot problems. The alarm logs maintain a record of the all reported failures by asset, providing a way to search and filter for specific issues. The alarms logs can also be exported as a CSV data file for additional processing.
- **Reporting:** The reporting engine provides several built-in reports that can be run on an individual asset, selected assets, or an entire city. Energy reports provide an easy way to track energy use and compare performance across different lighting assets. Data log reports enable trending selected points (e.g. light level, wattage, schedules, etc.) for a defined period of time to help analyze behavior and track any anomalies. All reports can be exported to CSV or PDF formats.

iNET™ IoT Intelligent Lighting Control System

iNET GATEWAY

Product Description

The Gateway connects installed wireless luminaire controllers with the central management system through an ethernet link for LAN connections or 4G link via an integrated cellular modem. The Gateway supports up to 1,000 controllers up to a 1000m line of sight, ensuring secure and robust communication to your lighting network.



Product Specifications

Cellular and Ethernet Gateway Specifications

•Wireless parameters

- Network type: star-mesh repeater
- IEEE 802.15.4
- Operating frequency: 433 MHz
- RF power: +24 dBm
- Range: 1000m line of sight
- Number of controllers supported:1,000

•Connectivity

- Cellular: universal 4G carriers
- Ethernet: wired ethernet 10/100

•Mounting and interface

- Mounting: wall or pole

•Operation

- IP rating: NEMA 4x (IP66 certified)
- Temperature range: -30°C ~ +75°C
- Voltage: 120-277(50/60 Hz)

•5-year limited warranty

Features/Benefits

- Connects iNET controllers in the field through a secure, reliable, and scalable network to a central management system software.
- Ethernet link for LAN connection or cellular link via built-in 4G modem for compatibility with any wireless carrier service.
- Supports up to 1,000 controllers up to a 1000m line of sight.
- Secure AES 128-bit encryption for wireless data transmission.
- 110 ports for additional sensor input.
- Built-in lightning surge arrester on all antenna ports.
- Works in extended temperature range conditions without service interruptions.

Applications

- Roadway lighting
- High mast lighting
- Site and large areas
- Campuses
- Auto dealerships

Dimensions

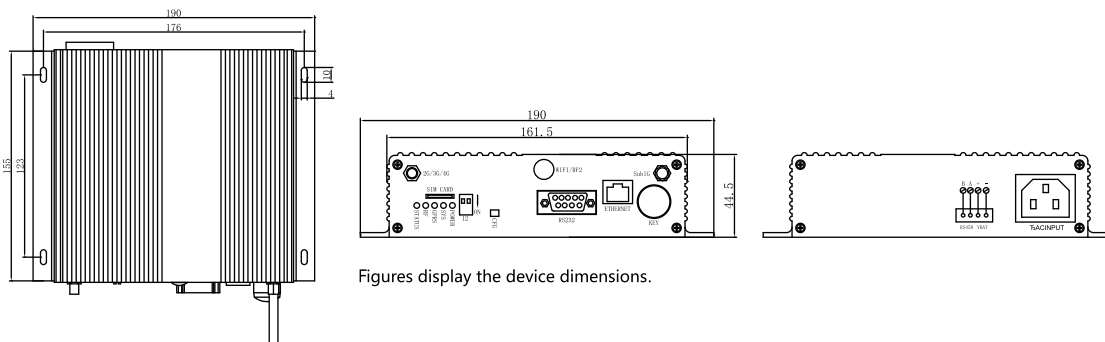

Figures display the device dimensions.

iNET™ IoT Intelligent Lighting Control System

WIRELESS OUTDOOR LIGHTING CONTROLLER NODE

Product Description

The node is a small wireless controller that installs directly to the exterior of the lighting fixture, enabling energy metering, remote monitoring and control. The controller node gathers data regarding the operational condition of lamps, energy usage, voltage, current, power factor, and fixture location that is transmitted over the iNET control network and analyzed by the iNET central management system (CMS) software.

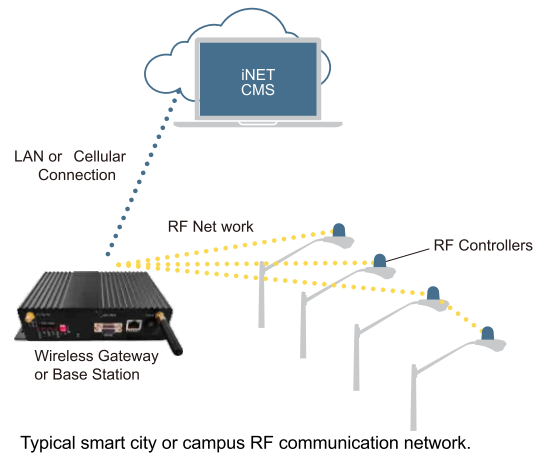

Operation

With the controller, fixtures can be addressed and grouped for unified ON/OFF, high-low stepped dimming with OFF, or 0-10 volt continuous dimming operation. A high end trim setting can enhance energy savings. The node provides adjustable photo - cell thresholds as well as time of day and astronomical clock functionality. It can operate without a network connection using its build-in intelligent control, which can store the data for up to a month. The node also supports peer to peer communications and wireless upgrades.

Features and Benefits

- Wireless communications for remote control, energy management and monitoring
- Provides auxiliary power for sensors
- Interfaces 0-10V driver
- Energy metering calibrated to 0.5% accuracy
- Built-in photocell
- Secure AES encryption
- Supports automatic repeater functionality for optimal coverage
- Mesh network supporting peer to peer communications
- Supports continuous and up-to-the-moment status updates to the CMS
- Integral GPS receiver (optional)

Control parameters

- **Control profiles and interfaces**
 - Power to fixture ON/OFF
 - Bi-level with OFF
 - Continuous dimming control with OFF
 - High end trim for enhanced energy savings
- **Control events and schedules**
 - Calendar based scheduling
 - Scheduled events based on time of day and/or astronomical time
 - Scheduled use of photocell
 - Real-time commands and overrides
- **Photocell daytime override**
- **Data logging**
- **Failure detection and reporting**
- **Photocell thresholds synchronization**
- **Continuous status messages**
- **Over the air flashing (program updates)**

INET™ IoT Intelligent Lighting Control System

WIRELESS OUTDOOR LIGHTING CONTROLLER NODE



Node-Standard Version

The control node is installed inside the light fixture, normally inside drive box. The node communicates with the gateway using SUB-1GHz protocol (ISM 433 MHz).

Electrical and operational specifications

Basic Specifications	Description
Operating voltage:	100-277VAC, 50/60 Hz
Power switching:	450W
Power consumption	1.5W@ 120/277V
Operating temperature	° ~ +75°C
Surge protection	4KV
Relay protection	Zero crossing
Failsafe	Power ON, lamp level high
Wireless communication	IEEE 802.15.4; 433 MHz 10 channel DSSS (Direct Sequence Spread Spectrum) RF power +22 dBm (250 mW)
Node to node range	1km(line of sight)
Node to gateway range	1km(line of sight)
Range extender	Node can be used as repeater
Input/interface	Motion sensor
Outputs/interfaces	0-10V (sink) dimming, 12VDC (50mA)
Protection	IP66

Measurement and Control

The Node is connected to incoming AC mains and the LED driver. Its MCU manages data communication, sensor control, remote switching, fault management and status reporting.

Sensors & Expandability

- The node provides extra I/O ports for outside sensor connection.

Dimensions

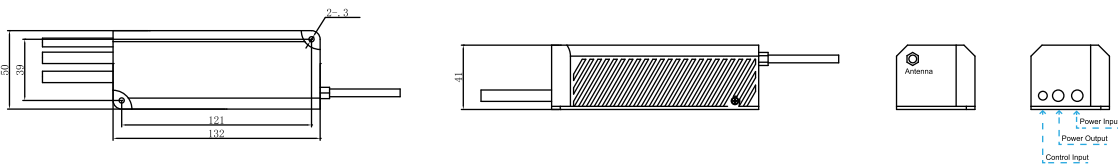

Figures display the device dimensions.

INET™ IoT Intelligent Lighting Control System

WIRELESS OUTDOOR LIGHTING CONTROLLER NODE

Node-NEMA Version (NEMA7)

The NEMA node is installed with the NEMA socket of the light fixture, it is commonly used for street light or area lighting fixtures. The node communicates with the gateway using SUB-1GHz protocol (ISM 433 MHz).



Electrical and operational specifications

Basic Specifications	Description
Operating voltage:	100-277VAC, 50/60 Hz
Power switching:	450W
Power consumption	1.5W@ 120/277V
Operating temperature	° ~ +75°C
Surge protection	4KV
Relay protection	Zero crossing
Failsafe	Power ON, lamp level high
Wireless communication	IEEE 802.15.4; 433 MHz 10 channel DSSS (Direct Sequence Spread Spectrum) RF power +22 dBm (250 mW)
Node to node range	1km(line of sight)
Node to gateway range	1km(line of sight)
Range extender	Node can be used as repeater
Input/interface	Motion sensor
Outputs/interfaces	0-10V (sink) dimming, 12VDC (50mA)
Protection	IP66

Measurement and Control

The Node is connected to the NEMA socket, which is in serial connection between AC mains and the LED driver. Its MCU manages data communication, sensor control, remote switching, fault management and status reporting.

Sensors & Expandability

- Onboard sensor option - photocell.
- The node provides extra I/O ports for outside sensor connection.

Dimensions and Wiring

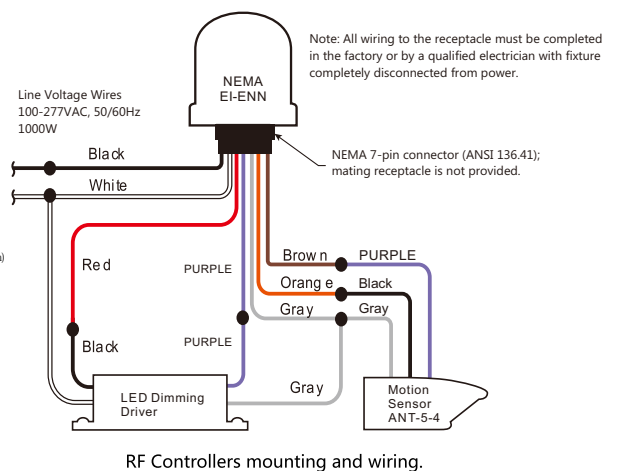
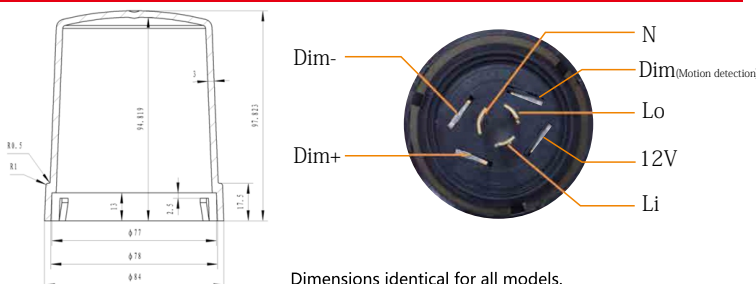

INET™ IoT Intelligent Lighting Control System

ORDERING INFORMATION

INET GATEWAY (Standard)

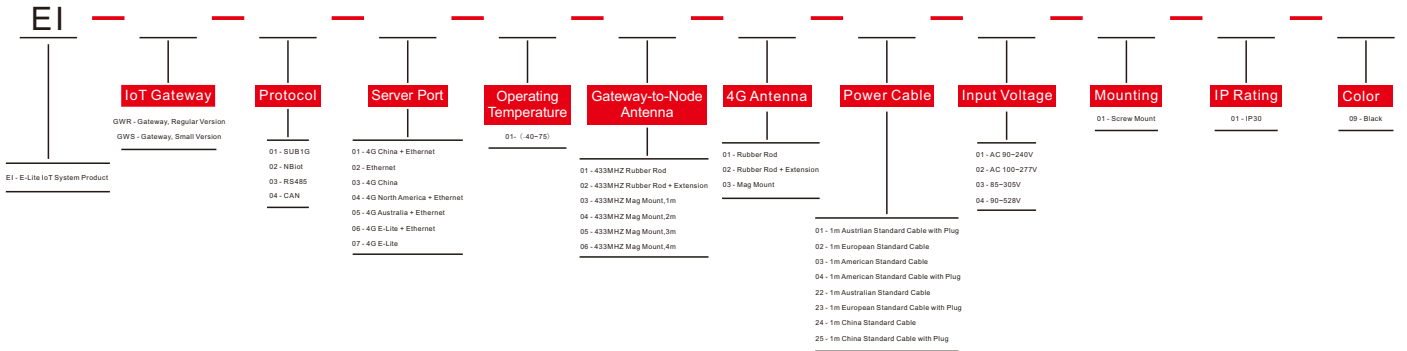

WIRELESS OUTDOOR LIGHTING CONTROLLER NODE (Standard)

