

**E-LITE**



**Titan**



# THE CHOICE OF THE SPORTS LIGHTING

Titan, true to its name, an innovative sports light provides excellent illumination of the stadium area under controlling of spill light and accurate angles for comfortable playing and visual sensation. Titan already be there.



Recreational sports



Multi-sports halls



Areas for controlled spill light



Apron spaces



Transportation & industrial areas

## TITAN, TO THE CHANGING WORLD

Today, we live in a 24-hour society. After a busy day of work, we need enjoy the energy, passion and exercise from exercise which can brings us balance, harmony, well-being and fun. So people are looking for flexibility to do sports in their free time. For sports clubs and centers, adaptable lighting is essential.



## FLEXIBLE LIGHT CONTROL

As the standard U bracket and the round compact design, the Titan sports light can be adjusted 360° horizontally and 180° vertically to ensure even light for every corner of the sports field but no light pollution to other areas.



## LIGHT JUST RIGHT FOR ATHLETES

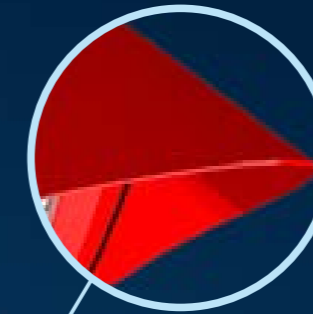

The Titan LED sports light provide optimum visibility, without glare or shadows as the special shield and optics design. Then every athlete, whatever their sports, can enjoy themselves, perform at their best and avoid injury.

## BETTER LIGHT FOR THE ENVIRONMENT

The quality of eyesight of young people is gradually dropping because the dramatically growing use of electronic products. And obesity through a sedentary lifestyle is also increasing, so it is more important than ever to encourage young people to do sports regularly. The LED lighting system can support the creation of healthier environment and encourage greater participation in recreational sports. It uses less energy and reduces carbon footprint.

# LIMIT THE LIGHT POLLUTION

## SKY GLOW

The haze or glow of light emitted above a lighting installation is a form of light pollution referred to as sky glow, must conform to Sports and Recreational Area Lighting requests of IES RP-6-15/ EN 12193. Sky glow can be minimized by reducing the amount of up-light cast into the sky. For the light emitted into the sky directly from the luminaire, external shielding (visors) can be added.

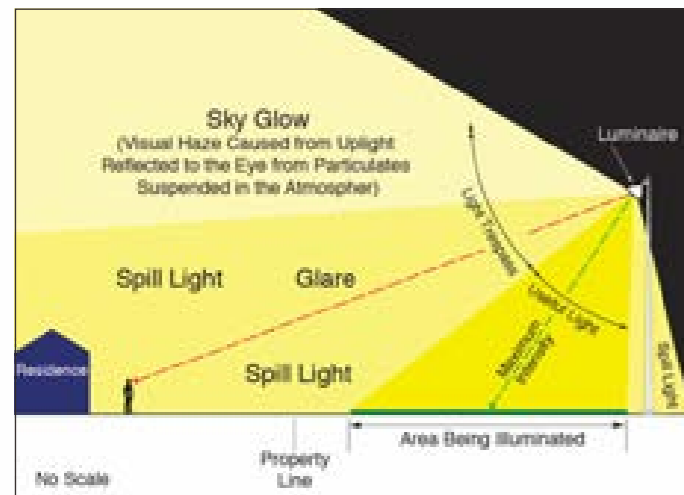

Obtrusive Light Components.

## SPILL LIGHT

Any light that falls beyond the area that is being illuminated that is not intentional or required is considered spill light. Although spill light should generally be controlled in residential areas, reactions to spill light often vary. Some residents are ambivalent with regard to spill light, or may even prefer spill light on their property to enhance their feeling of security, while other residents want the spill light directed away from their property.

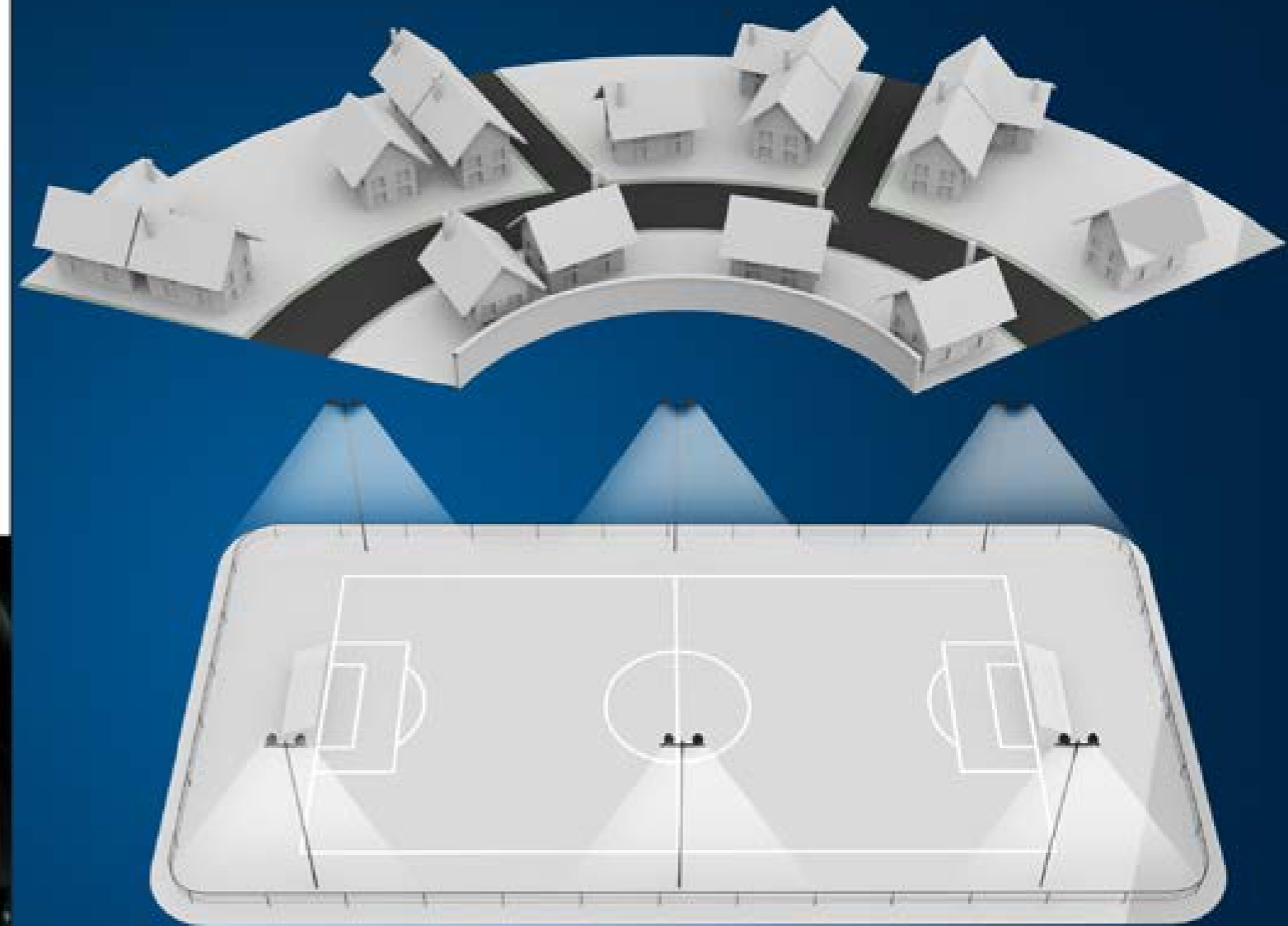

## GLARE

The impacts of glare should generally be reduced. Glare typically impacts larger areas as pole mounted luminaires may be visible from long distances. The use of luminaires that incorporate internal and/or external shielding (visors) to limit direct view of light sources help reduce glare.

## LIGHT SPILL CONTROL

## GREATER LIFE EXPECTANCY IN WARMER CLIMATES

Proprietary thermal efficient design with passive cooling maximizes heat dissipation for longer life of the luminaire.

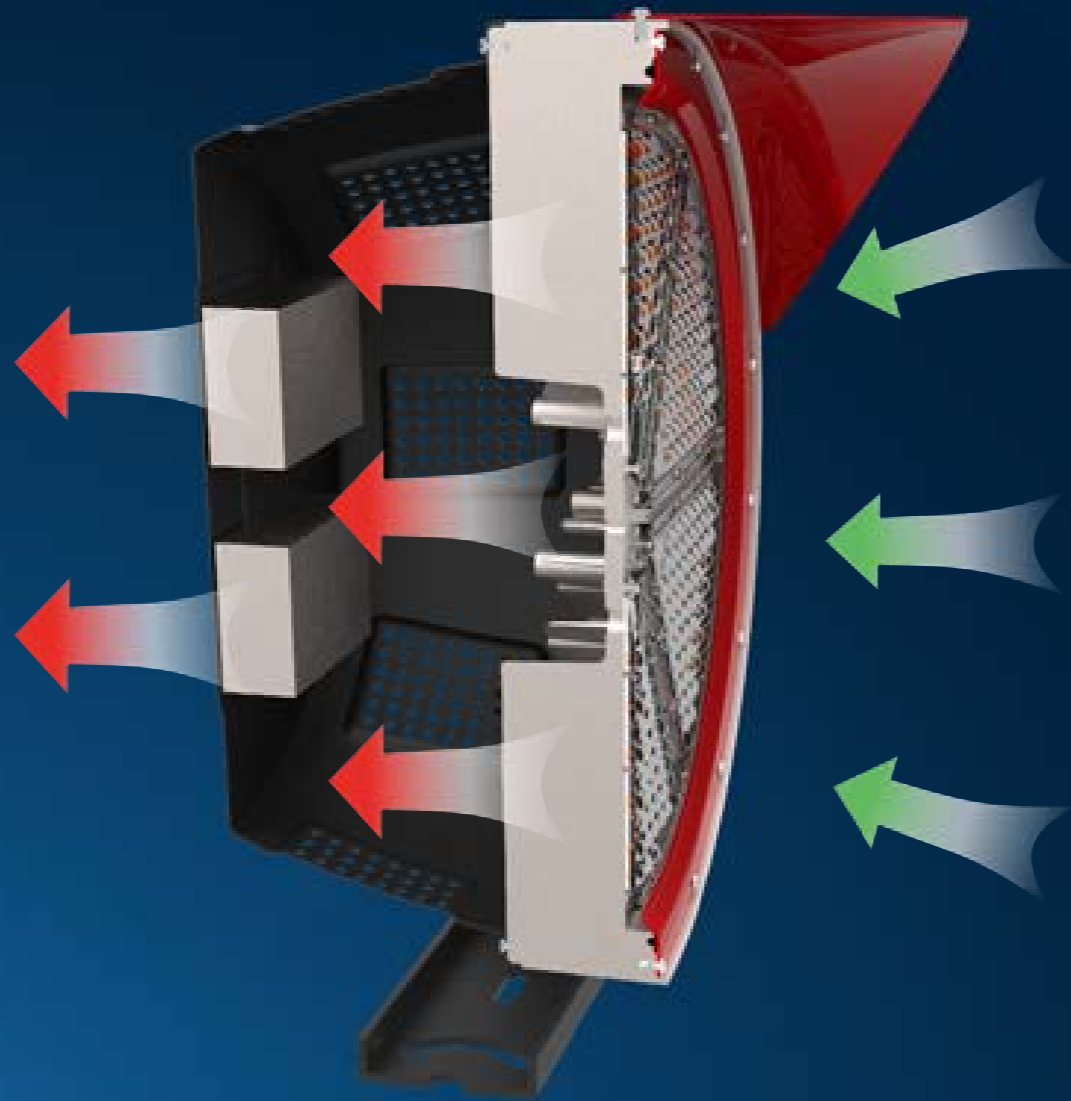

## AERODYNAMIC DESIGN FOR MINIMAL WIND RESISTANCE

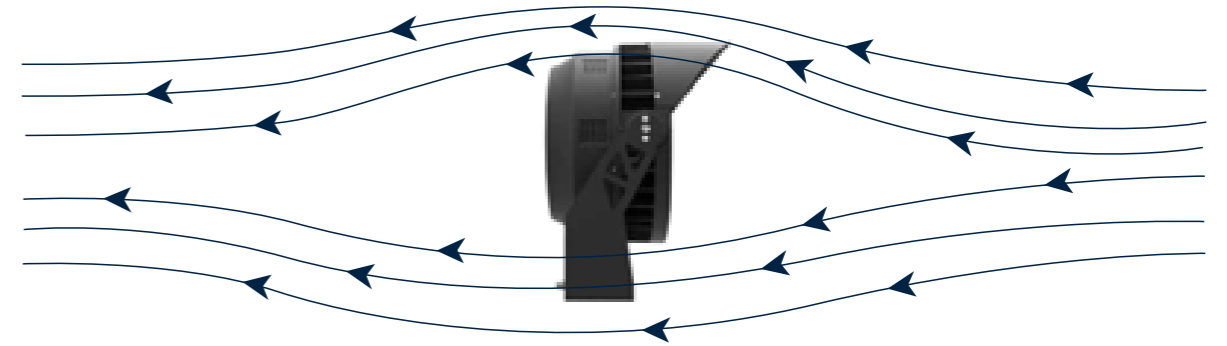

During outside projects, it is important to consider the weight and windage of selected products and their suitability for existing or proposed mounting structures. Note that a floodlight mounted horizontal to the ground, as with an asymmetric distribution, helps to decrease windage and provides better control of spill light.



# INSTALLATION

Safety and simplicity are crucial when installing and maintaining a sport light at great heights. As a complete lighting solution for both outdoor and indoor spaces, Titan is ideally suited for a large variety of mast configurations, mountings and heights. Featuring a lighter, more compact design and improved thermal management, it is much easier to install

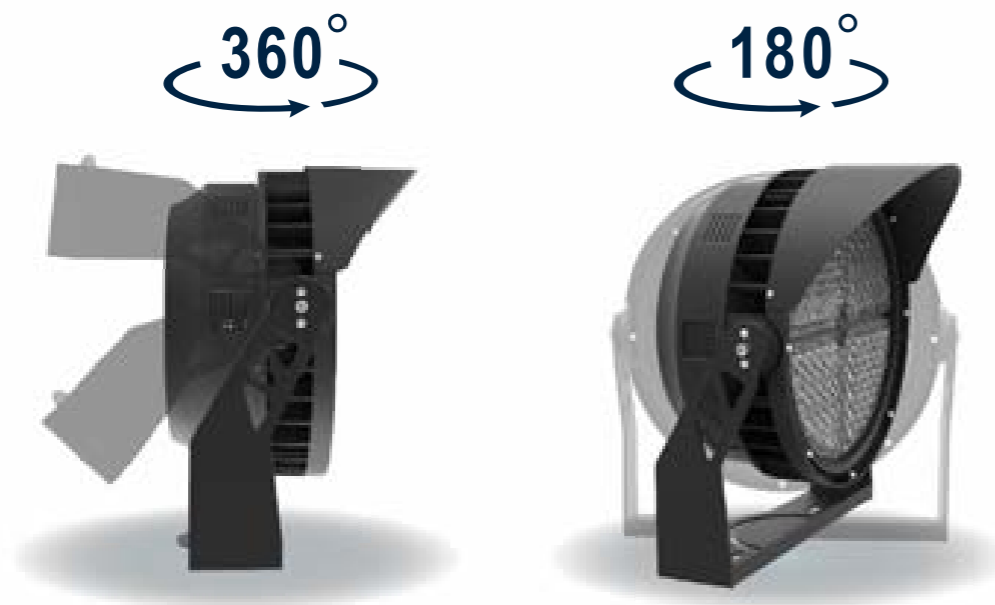

# PERFORMANCE

	300W~1500W
	140lm/W~165lm/W
	Philips Lumileds
	AC 100~277V / AC 200~480 V
	0.95 min
	Sosen / Inventronics
	≥70
	4500~5500K (2500~6500K Optional)
	L70>120,000hours
	15° for ( 300W~1500W ) and 30°/60°/90° for ( 300W~800W ) and 30° for (1000W~1500W)
	IP66 / IP67
	IK10
	3G Vibration
	Operating Temperature:-45°C to +45°C (-49°F to 113°F) Storing Temperature:-45°C to +80°C (-49°F to 176°F)





## SPECIFICATIONS

Model	Power	Efficacy(IES)	Total Lumen	Product Dimensions
EL-SLTT-300	300W	160LPW	48,000lm	483×450×321mm 19.0×17.7×12.6in
EL-SLTT-400	600W	150LPW	60,000lm	483×450×321mm 19.0×17.7×12.6in
EL-SLTT-500	500W	145LPW	72,500lm	483×450×321mm 19.0×17.7×12.6in
EL-SLTT-600	600W	160LPW	96,000lm	581.3×537×321mm 22.8×21.1×12.6in
EL-SLTT-800	800W	150LPW	120,000lm	581.3×537×321mm 22.8×21.1×12.6in
EL-SLTT-1000	1000W	165LPW	165,000lm	715×640×468mm 28.1×25.2×18.4in
EL-SLTT-1200	1200W	160LPW	192,000lm	715×640×468mm 28.1×25.2×18.4in
EL-SLTT-1300	1300W	155LPW	201,500lm	715×640×468mm 28.1×25.2×18.4in
EL-SLTT-1500	1500W	150LPW	225,000lm	715×640×468mm 28.1×25.2×18.4in



# PHOTOMETRICS

15°

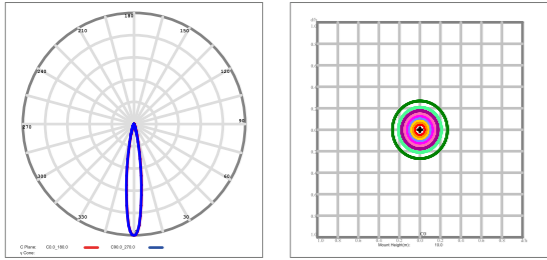

30°

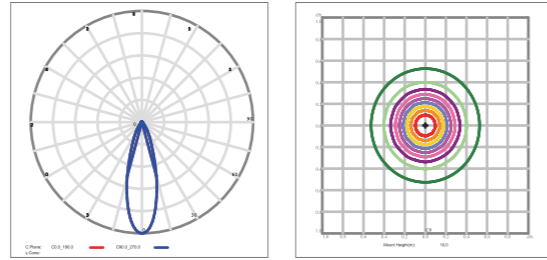

60°

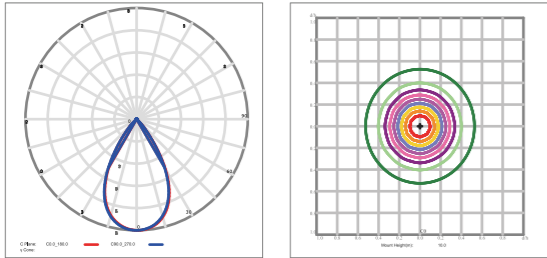

90°

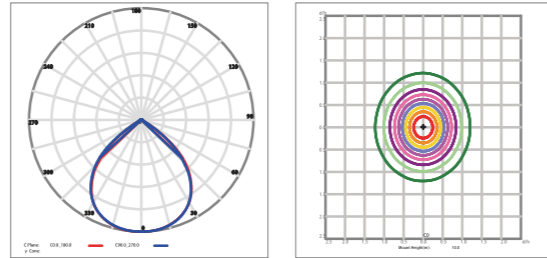



# ORDERING INFORMATION

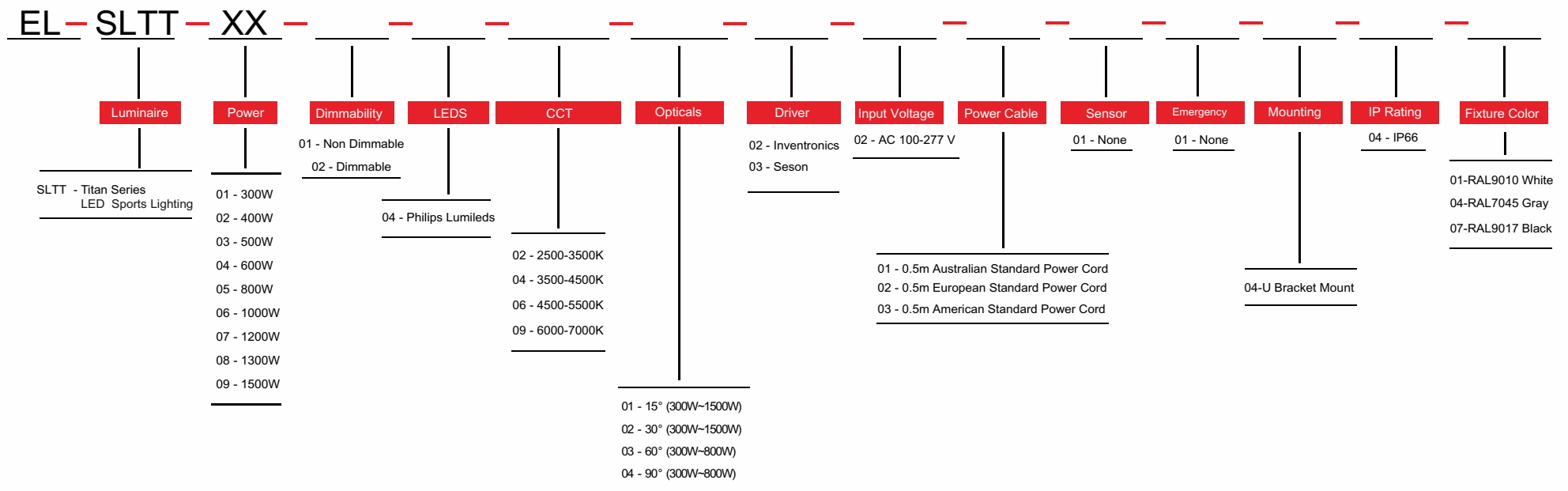

E-Lite Semiconductor Co., Ltd.  
Headquarter & Factory  
Website: <http://www.elitesemicon.com>